

PC170 Control Box

24V DC GEAR MOTOR

FOR RESIDENTIAL
USER MANUAL

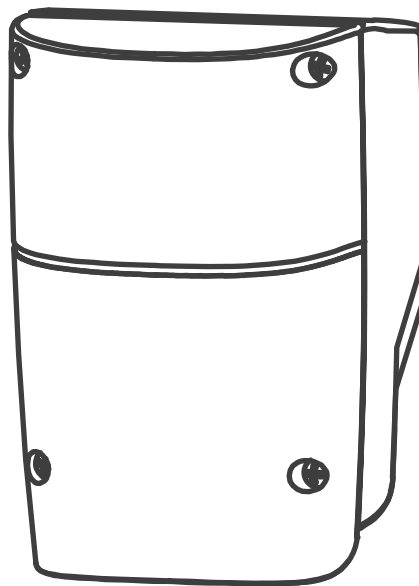

INDEX

1.	CONTROL BOX	1
2.	SETTING	3
2.1	SW1 DIP SWITCH SETTING	3
2.1.1	SLOWDOWN ADJUSTMENT (DIP 1. SLOW)	3
2.1.2	OVER-CURRENT ADJUSTMENT (DIP 2.OVER C1 & DIP 3.OVER C2)	3
2.1.3	GATE AUTO-CLOSE ADJUSTMENT (DIP 4.AUTO C1, DIP 5.AUTO C2 & DIP 6.AUTO C3)	3
2.1.4	PEDESTRIAN MODE ADJUSTMENT (DIP 7.P MODE)	4
2.1.5	FLASHING LIGHT ADJUSTMENT (DIP 8.LIGHT)	4
2.2	SW2 DIP SWITCH SETTING	4
2.2.1	PHOTOCELL ADJUSTMENT (DIP 1.PHOTO1, DIP 2.PHOTO2)	4
2.2.2	CLOSE DELAY OF DUAL GATE OPERATION ADJUSTMENT (DIP 3.DELAY1, DIP 4.DELAY2)	5
2.2.3	ELECTRIC LATCH ADJUSTMENT (DIP 5.LATCH)	5
2.2.4	DECELERATION SPEED ADJUSTMENT OF THE GEAR MOTORS (DIP 6. D SPEED)	5
2.2.5	OPERATION SPEED ADJUSTMENT OF THE GEAR MOTORS (DIP 7. O SPEED)	5
2.2.6	SINGLE AND DUAL GATE OPERATION ADJUSTMENT (DIP 8.DS/SET)	5
2.3	LED INDICATION	5
2.4	TRANSMITTER MEMORIZING AND ERASING PROCESS	6
2.5	SYSTEM LEARNING PROCESS	6
2.6	GATE OPERATION	6
2.7	GATE-MOVING LOGIC	6
2.8	ADVANCED OPERATION OF THE TRANSMITTER	7
3.	TROUBLE SHOOTING	7

1. CONTROL BOX

CONTROL BOX INSTALLATION

1. Decide the installation position of control box first, it is suggested to be installed near the gate and should be protected from possible damage. Be aware of the motor cable length before deciding the installation position.
2. Remove the cover by unscrewing the four screws on the cover. See **Figure 1(1)**.
3. Use a screwdriver to puncture the holes beneath the bottom of the control box. See **Figure 1(2)**.
4. Secure it on the wall. See **Figure 1(3)**.

Figure 1(1)

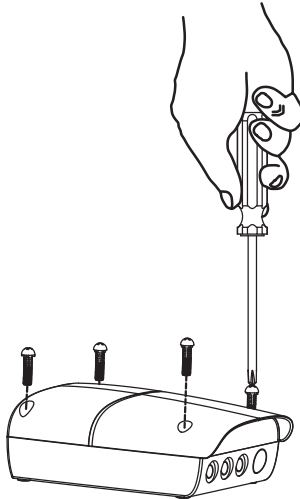

Figure 1(2)

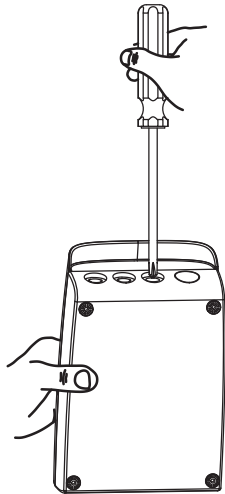
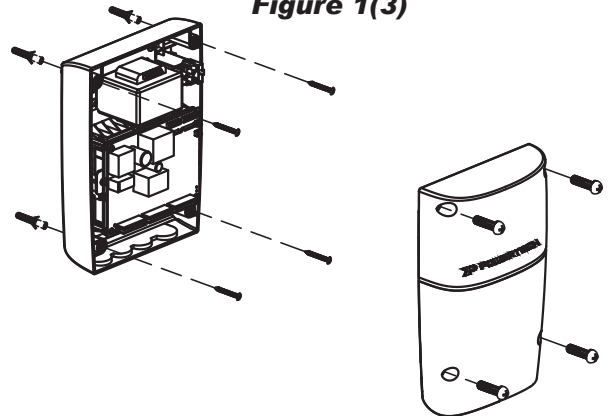

Figure 1(3)



5. Wiring Connection:

Prepare all the wires of the accessories beforehand and connect the wires to the gear motors and accessories on the PCB as shown in **Figure 1(4)**. All of the wiring connections of the accessories are not requested to distinguish the positive (+) and the negative (-) polarity.

- 1). Flashing light: Connect the two wires from the flashing light to the terminal L+ and L- on the PCB.
- 2). Electric Latch: Connect the two wires from the electric latch to the terminal Lo + and Lo- on the PCB.
- 3). Gate openers: Refer to Figure 1(4) and connect the wires separately to the terminals on the PCB.

Motor 1: Connect the motor wire (White +) to the terminals Mo1 +, and (Yellow -) to the Mo1-.

Motor 2: Connect the motor wire (White +) to the terminals Mo2 +, and (Yellow -) to the Mo2 -.

Notes:

For gates opened outward,

Motor 1: Connect the motor wire (Yellow -) to the terminals Mo1 +, and (White +) to the terminals Mo1-.

Motor 2: Connect the motor wire (Yellow -) to the terminals Mo2 +, and (White +) to the terminals Mo2 -.

4). Photocells: **See Figure 1(4)**

(A). In the installation of one set: Connect the wires referred to 7 and 9.

And switch Ph connect1 of SW3 to ON position for activating the function.

(B). In the installation of two sets: connect the wires referred to 7, 8, 9 and 10.

Ph connect1 And switch Ph connect1 and Ph connect2 of SW3 to ON position for activating the function.”.

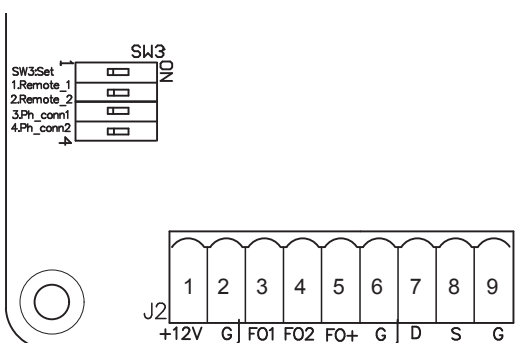
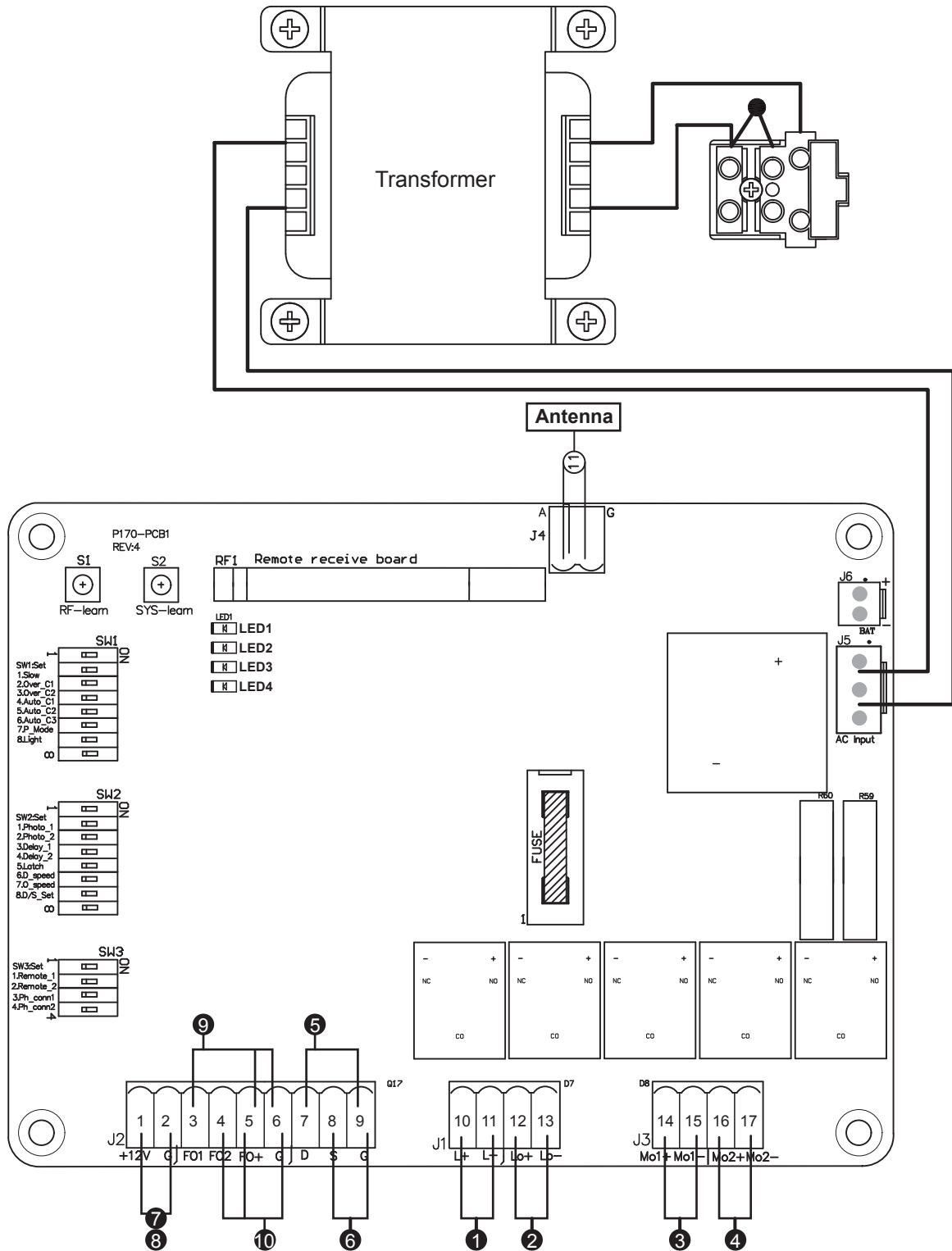



Figure 1(4)



- 1



- 2

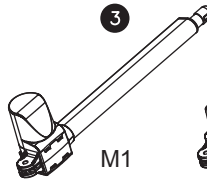

Latch
- 3

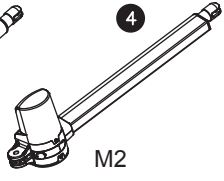

M1
- 4



M2
- 5



Key Selector
- 6



Push Button
- 7

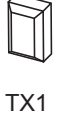

TX1
- 8

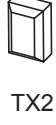

TX2
- 9



RX1
- 10



RX2

2). SETTING

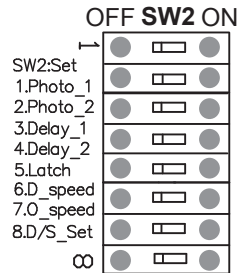
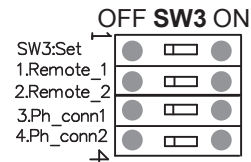
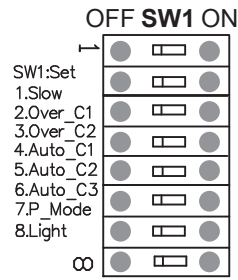
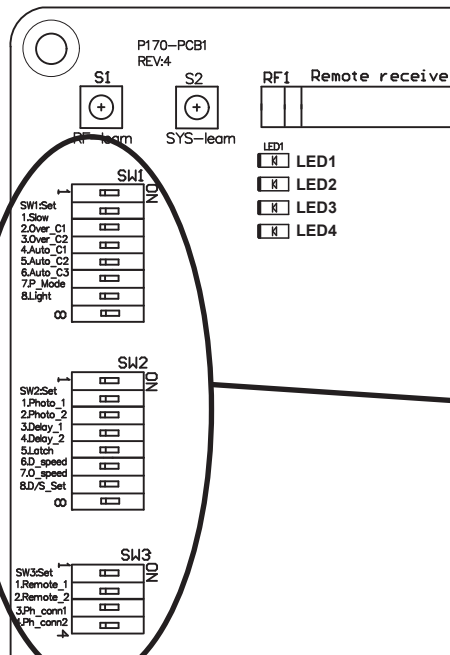

Before powering on the control unit, the following dip switch setting must be decided by gate weight and installation environment first. See **Figure 2**

NC: No Connection

2.1 SW1 DIP SWITCH SETTING

2.1.1 SLOWDOWN ADJUSTMENT (DIP 1.SLOW)

ON: The gear motors do not slow down before the gates completely close or open.

OFF: The gear motors slow down before the gates completely close or open.

2.1.2 OVER-CURRENT ADJUSTMENT (DIP 2.OVER C1 & DIP 3.OVER C2)

OVER C1	OVER C2	Current (Amp)
Dip Switch 2 OFF	Dip Switch 3 OFF	2A
Dip Switch 2 OFF	Dip Switch 3 ON	3A
Dip Switch 2 ON	Dip Switch 3 OFF	4A
Dip Switch 2 ON	Dip Switch 3 ON	5A

2.1.3 GATE AUTO-CLOSE ADJUSTMENT (DIP 4.AUTO C1, DIP 5.AUTO C2 & DIP 6.AUTO C3)

Auto C1	Auto C2	Auto C3	Effect
Dip switch 4 OFF	Dip Switch 5 OFF	Dip Switch 6 OFF	No auto-close
Dip switch 4 OFF	Dip Switch 5 OFF	Dip Switch 6 ON	3 sec.
Dip switch 4 OFF	Dip Switch 5 ON	Dip Switch 6 OFF	10 sec.
Dip switch 4 OFF	Dip Switch 5 ON	Dip Switch 6 ON	20 sec.
Dip switch 4 ON	Dip Switch 5 OFF	Dip Switch 6 OFF	40 sec.
Dip switch 4 ON	Dip Switch 5 OFF	Dip Switch 6 ON	60 sec.
Dip switch 4 ON	Dip Switch 5 ON	Dip Switch 6 OFF	120 sec.
Dip switch 4 ON	Dip Switch 5 ON	Dip Switch 6 ON	360 sec.

Note: Auto-close mode activates when the gates move to the end position or stopped manually. If the transmitter, push button, or the key selector is activated before the auto-close counting, the gate will close immediately.

2.1.4 PEDESTRIAN MODE ADJUSTMENT (DIP 7.P MODE)

ON: The pedestrian mode is working by command B button on remote for partially open of gate.

OFF: The pedestrian mode is disabled.

2.1.5 FLASHING LIGHT ADJUSTMENT (DIP 8.LIGHT)

ON: The flashing light blinks for 3 seconds before the gate moves, and blinks simultaneously during the movement.

OFF: The flashing light blinks and the gate moves simultaneously.

2.2 SW2 DIP SWITCH SETTING

2.2.1 PHOTOCCELL ADJUSTMENT (DIP 1.PHOTO1, DIP 2.PHOTO2)

1. SW2_2, SW2_1: OFF OFF

Position of Gate	When safety devices are activated	
Type of Safety Device	Safety Device2 : Photocell-OPEN	Safety Device1 : Photocell-CLOSE
FULLY CLOSED	Open not allowed	No effect
FULLY OPENED	No effect	Reload automatic closing time
STOP DURING MOVING	Open not allowed	Reload automatic closing time
CLOSING	No effect	Open
OPENING	Close	No effect

2. SW2_2, SW2_1: OFF ON

Position of Gate	When safety devices are activated	
Type of Safety Device	Safety Device2 : Safety Edge	Safety Device1 : Photocell-CLOSE
FULLY CLOSED	Open not allowed	No effect
FULLY OPENED	Reload automatic closing time	
STOP DURING MOVING	Locks	Reload automatic closing time
CLOSING	Reverse to open for 2 seconds	Open
OPENING	Reverse to close for 2 seconds	No effect

3. SW2_2, SW2_1: ON OFF

Position of Gate	When safety devices are activated	
Type of Safety Device	Safety Device2 : Opening Device	Safety Device1 : Photocell-CLOSE
FULLY CLOSED	Open	No effect
FULLY OPENED	Reload automatic closing time	
STOP DURING MOVING	Open	Reload automatic closing time
CLOSING	Open	Open
OPENING	No effect	No effect

4. SW2_2, SW2_1: ON ON

Position of Gate	When safety devices are activated	
Type of Safety Device	Safety Device2 : Photocell-OPEN/CLOSE	Safety Device1 : Photocell-CLOSE
FULLY CLOSED	Open not allowed	No effect
FULLY OPENED	Close not allowed, Open for 2 seconds when auto closing is ON	
STOP DURING MOVING	Locks	Close not allowed
CLOSING	Stop	Open
OPENING	Stop	No effect

2.2.2 CLOSE DELAY OF DUAL GATE OPERATION ADJUSTMENT (DIP 3.DELAY1, DIP 4.DELAY2)

Close/Open delay of two leaves of gate can be adjusted from 2 to 6 seconds

DIP switch		Open Delay	Close Delay
Dip3. Delay 1	Dip4. Delay 2		
OFF	OFF	2 sec	3 sec
ON	OFF	2 sec	4 sec
OFF	ON	3 sec	5 sec
ON	ON	3 sec	6 sec

2.2.3 ELECTRIC LATCH ADJUSTMENT (DIP 5.LATCH)

ON: The master leaf will move toward closing direction for 0.25 second once command the remote, then unlock the latch to open the gate.

OFF: Once command the remote, the the latch will be unlocked to open the gate immediately

2.2.4 DECELARATION SPEED ADJUSTMENT OF THE GEAR MOTORS (DIP 6. D SPEED)

ON: The speed is 70% output of the full speed.

OFF: The speed is 50% output of the full speed.

2.2.5 OPERATION SPEED ADJUSTMENT OF THE GEAR MOTORS (DIP 7.O SPEED)

ON: The speed is 100% output of the full speed.

OFF: The speed is 70% output of the full speed.

2.2.6 SINGLE AND DUAL GATE OPERATION ADJUSTMENT (DIP 8.DS/SET)

ON: Dual Gates operation in system learning and normal operation.

OFF: Single Gate operation in system learning and normal operation.

2.3 LED INDICATION

LED1 System Learning: LED1 is always ON when the system learning in not completed.

LED1 blinks once when single-gate learning is completed ;

LED1 blinks twice when dual-gate learning is completed.

LED2 RF : If the switch of the transmitter, key selector, or the push button is activated, LED2 will be on.

LED3 Photocells 1 : LED3 will be on when the first pair of the photocells are activated.

LED4 Photocells 2 : LED4 will be on when the second pair of the photocells are activated.

LED5 RF Indicator : LED5 will be on when RF signal is received.

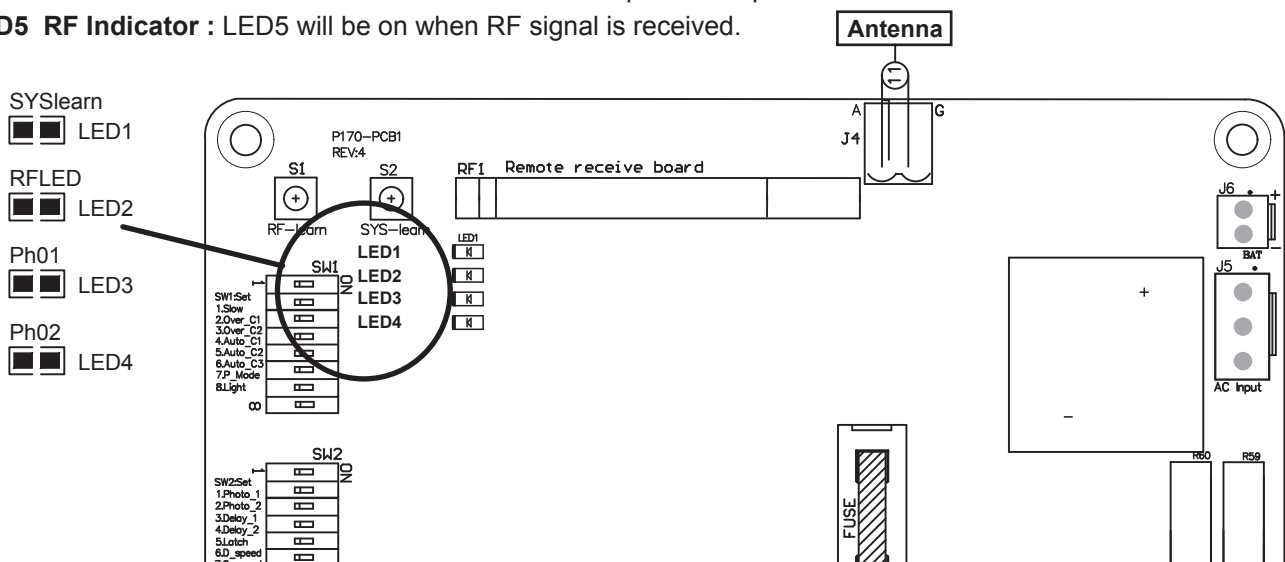

2.4 TRANSMITTER MEMORIZING AND ERASING PROCESS

- (A) Transmitter Memorizing: Press and hold the S3 button on the PCB for 3 second and then the blue LED indicator on the RF board will be “ON”. Press A button for dual-gate installation ; press B button for single-gate installation on the transmitter within 5 seconds. The transmitter learning is completed when the blue indicator is “OFF”.
- (B) Transmitter Memory Erasing: Press and hold the S3 button on the PCB for three seconds.
- (C) One radio receiver can be memorized with 200pcs of transmitters.

2.5 SYSTEM LEARNING PROCESS

- Step1:** Connect the master motor wires to Motor1 terminals and the slave motor wires to Motor2 terminals correctly. If only one gate is installed, the motor wires have to be connected to M1 terminals.
- Step2:** Switch Ph conn1 and Ph conn2 of SW3 to ON position for entering the system learning mode
- Step3:** Press and hold the SYS-learn button on the PCB for 5 seconds. After LED1 blinks once per second, press the button on the transmitter to choose dual-gate(A button) or single-gate(B button) system learning. In system learning mode, the gates will proceed with the following procedures.
- (A) Dual-Gate Mode: Slave Gate closes→Master Gate closes→Master Gate opens→Slave Gate opens→Slave Gate closes→Master Gate closes.
- (B) Single-Gate Mode: Master Gate closes→Master Gate opens→Master Gate closes.

The completion of system learning:

- (A) For Dual-Gate installation: The system learning is completed when LED1 quickly blinks twice per second. (B) For Single-Gate installation: The system learning is completed when LED1 quickly blinks once per second.

Notes:

- (A) System learning fails and needs to be learned again when an unpredictable interruption occurs.
- (B) Once the system learning is completed, there is no need to proceed with the learning process again when there is a power failure.
- (C) The slave gate opens 3 seconds after the master gate opens and the master gate closes 3 seconds after the slave gate closes.

2.6 GATE OPERATION

Press the button “A” on the transmitter for dual-gate operation.

Press the button “B” on the transmitter for single-gate operation in either single-gate or dual-gate installation.

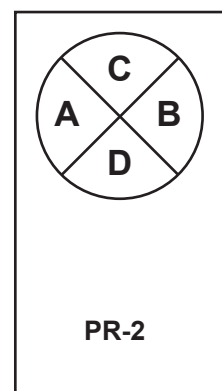

2.7 GATE-MOVING LOGIC

- (A) In gate-opening phase: The gates stop if the transmitter/push button/key selector is activated, and close when the transmitter/push button/key selector is reactivated.
- (B) In gate-closing phase: The gates stop if the transmitter/push button/key selector is activated, and open when the transmitter/push button/key selector is reactivated.
- (C) In gate-opening or gate-closing phase: For safety purpose, the gates stop if encountering obstacles.

2.8 ADVANCED OPERATION OF THE TRANSMITTER (SW3 DIP1/2 REMOTE 1 & REMOTE2)

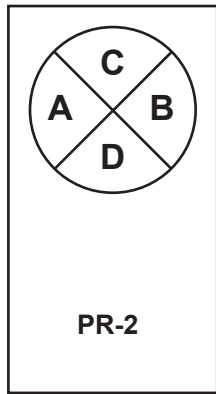

See the following description:

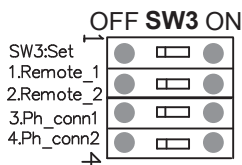

Situation 1: Dip1. Remote 1:ON & Dip2. Remote 2:ON

Transmitter button A for single leaf operation.

Transmitter button B for double leaves operation.

Situation 2: Dip1. Remote 1:ON & Dip2. Remote 2:OF

Transmitter button B for single leaf operation.

Transmitter button A for double leaves operation.

Situation 3: Dip1. Remote 1:OFF & Dip2. Remote 2:ON

Transmitter button C for single leaf operation.

Transmitter button D for double leaves operation.

Situation 4: Dip1. Remote 1:OFF & Dip2. Remote 2:OF

Transmitter button D for single leaf operation.

Transmitter button C for double leaves operation.

3. TROUBLE SHOOTING

Overheated Back-up Batteries	Check the wiring connection of the batteries.
The gate doesn't move when pressing the button of the transmitter	<ol style="list-style-type: none"> 1. Check if LED3 or 4 is "ON". 2. Check if the voltage of the batteries is below 22V. 3. Check if LED1 is "ON". 4. Make sure all the wiring connections are firmly connected to the terminals on the PCB. 5. Make sure the fuse is workable.
The gate only moves a little distance when pressing the button of the transmitter.	Make sure the wiring connection of the hall sensor is firm.
The transmitting distance is too short	Make sure the connecting terminals of the Antenna is firm.
The gear motors run very slowly	Check the dip switch setting of the speed adjustment.
The Flashing light does not work	Check if the wiring connection of the flashing light is correct.
The leaves shall be closed instead of opening	Change the polarity connection of the positive (+) with the negative (-) of the gear motors.
The leaves suddenly stop during moving	<ol style="list-style-type: none"> 1. Check if the "RESET" socket is activated. 2. Make sure the wiring connection of the gear motors is firm. 3. Make sure the hall sensor wiring connection is firm. 4. The GND terminal of the photocells on the PCB must be short-circuited if no photocells installed. 5. Make sure the fuse is workable.
The leaves does not move or only move toward one direction	<ol style="list-style-type: none"> 1. Check if the "RESET" socket is activated. 2. Make sure the wiring connection of the gear motors is firm. 3. Make sure the hall sensor wiring connection is firm. 4. The GND terminal of the photocells on the PCB must be short-circuited if no photocells installed.
The master gate closes to the end first and the slave gate stops, the flashing light blinks fast for five seconds.	Cut off the AC input power and the output of the batteries. Release the master gate and slave gate manually, then open the master to the end and close the slave gate to the end by hand, then power the whole unit by connecting the AC and battery terminals.
The gear motors does not run and the relay is noisy when operating the gate opening and closing	Check if the fuse is burned.



POWERTECH

THE STRONGEST SOLUTION
FOR SWING GATES

- Worm gear provides durability and silence in motor operation.
- Slowdown during opening and closing phase.